

Scarlett 18i8

User Guide

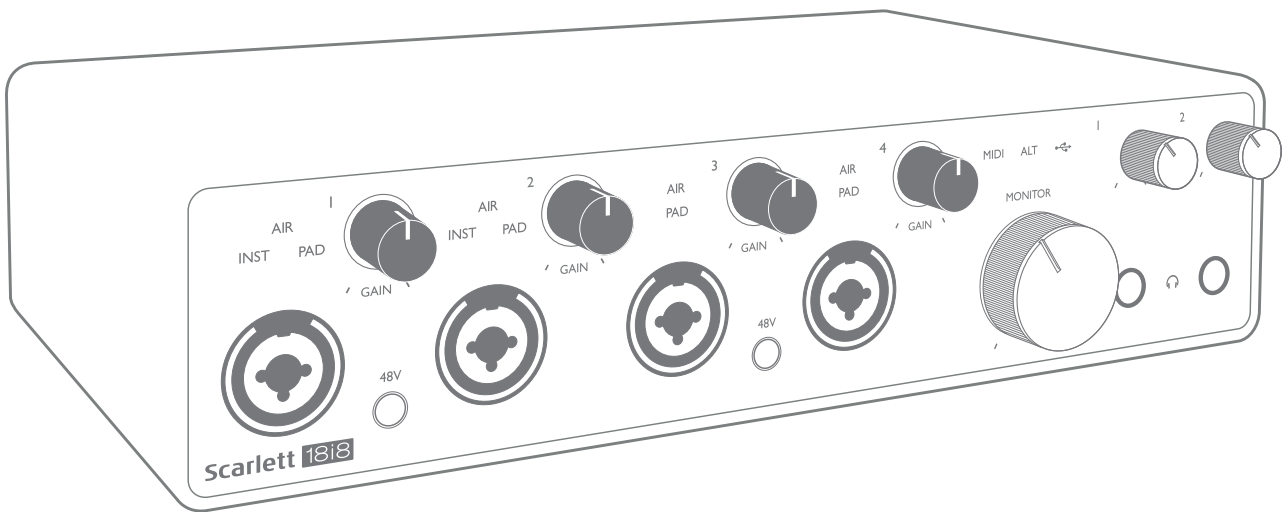

Focusrite®

TABLE OF CONTENTS

OVERVIEW	3
Introduction	3
Features	3
Box Contents	4
System requirements	4
GETTING STARTED	5
Quick Start Tool	5
Mac users only:	5
Windows only:	7
All users:	9
Manual Registration	9
HARDWARE FEATURES	10
Front Panel	10
Rear Panel	12
Connecting your Scarlett 18i8	13
Power	13
USB	13
Audio Setup in your DAW	14
Loopback Inputs	15
Examples of Usage	16
Connecting microphones and instruments	16
Low Latency Monitoring	17
Connecting Scarlett 18i8 to loudspeakers	18
Using the ADAT connection	20
Using the Scarlett 18i8 as a stand-alone mixer	21
Using the Scarlett 18i8 as a stand-alone preamp	21
FOCUSRITE CONTROL	22
Channel Listing tables	23
SPECIFICATIONS	25
Performance Specifications	25
Physical and Electrical Characteristics	27
TROUBLESHOOTING	29
COPYRIGHT AND LEGAL NOTICES	29

OVERVIEW

Introduction

Thank you for purchasing this Third Generation Scarlett 18i8, one of the family of Focusrite professional audio interfaces incorporating high quality Focusrite analogue pre-amplifiers. In conjunction with the unit's accompanying software application, Focusrite Control, you now have a compact yet highly versatile solution for routing high quality audio to and from your computer.

In developing the Third Generation series of Scarlett interfaces, we have made further improvements to both performance and features. Audio specifications have been upgraded throughout the unit to give you greater dynamic range and even lower noise and distortion; additionally, the mic preamp now accepts higher input levels. An important enhancement is the inclusion of Focusrite's AIR function. Individually selectable on Inputs 1 to 4, AIR subtly modifies the preamp's frequency response to model the sonic characteristics of our classic transformer-based ISA microphone preamps. When recording with good quality microphones, you will notice an enhanced clarity and definition in the important mid to high frequency range, just where it is most needed for vocals and many acoustic instruments. Third Generation Scarlett interfaces are class compliant on macOS: this means they are plug-and-play, so no need to install a driver if you are a Mac user.

Your Third Generation Scarlett interface is compatible with our Focusrite Control software application: this lets you control various hardware features, set up monitor mixes and configure routings. There is a Focusrite Control installer for both Mac and Windows platforms. The Windows version of the installer contains the driver, so in either case, you only need to install Focusrite Control to get up and running.

This User Guide provides a detailed explanation of the hardware to help you achieve a thorough understanding of the product's operational features. We recommend you take the time to read through the user guide, whether you're new to computer recording or a more experienced user, so you are fully aware of all the possibilities the Scarlett 18i8 and accompanying software have to offer. If the main User Guide sections do not provide the information you need, be sure to consult support.focusrite.com, which contains a comprehensive collection of answers to common technical support queries.

Features

The Scarlett 18i8 audio interface provides the means for connecting microphones, musical instruments, line level audio signals and digital audio signals in both ADAT and S/PDIF formats to a computer running compatible versions of Mac OS or Windows. The signals at the physical inputs can be routed to your audio recording software / digital audio workstation (referred to throughout this user guide as the "DAW") at up to 24-bit, 192 kHz resolution; similarly, the DAW's monitor or recorded output signals can be configured to appear at the unit's physical outputs.

The outputs can be connected to amplifiers and speakers, powered monitors, headphones, an audio mixer or any other analogue or digital audio equipment you wish to use. Although all inputs and outputs on the Scarlett 18i8 are routed directly to and from your DAW for recording and playback, you can configure the routing within your DAW to meet your precise needs.

The accompanying software, Focusrite Control, provides further routing and monitoring options, as well as the ability to control global hardware settings such as sample rate and clock source.

A new feature on the Third Generation 18i8 is the ALT function, which provides secondary monitor speaker switching. This lets you connect a second pair of monitor loudspeakers to Line Outputs 3 and 4 and switch between the pairs to reference your mix on a different set of speakers. The ALT function is configured and selected from Focusrite Control.

All inputs on the Scarlett 18i8 are routed directly to your DAW software for recording, but Focusrite Control also allows you to route these signals internally within the device to the outputs so you can monitor the audio signals with ultra-low latency - before they arrive at your DAW, should you need to do so.

The Scarlett 18i8 also has connectors for sending and receiving MIDI data; this lets you use it as a MIDI interface between your computer's USB port and other MIDI equipment in your system.

Box Contents

Along with your Scarlett 18i8 you should have:

- External 12 V DC mains Power Supply Unit (PSU)
- USB cable, Type 'A' to Type 'C'
- Getting Started Information (printed inside the box lid)
- Important Safety Information

System requirements

The easiest way to check your computer's operating system (OS) is compatible with your Scarlett is to use our Help Centre's compatibility articles:

support.focusrite.com/hc/categories/200693655

As new OS versions become available over time, you can continue to check for further compatibility information by searching our Help Centre at support.focusrite.com.

GETTING STARTED

With the Third Generation, Scarlett interfaces introduce a new, faster way of getting up and running, using the Scarlett Quick Start tool. All you need to do is power your Scarlett 18i8 using the mains adapter supplied, and connect its USB port to one on your computer. Once connected, you will see the device is recognised by your PC or Mac and the Quick Start tool will guide you through the process from there.

IMPORTANT: The Scarlett 18i8 has a single USB 2.0 Type C port (on the rear panel): connect it to your computer using the USB cable provided. Note that Scarlett 18i8 is a USB 2.0 device, and thus the USB connection requires a USB 2.0+ compliant port on your computer.

Your computer will initially treat your Scarlett as a Mass Storage Device (MSD), and during its first connection, the Scarlett will be in “Easy Start mode”

Quick Start Tool

We have tried to make registering your Scarlett 18i8 as simple as possible. The steps are designed to be self explanatory, but we have described each step below, so you can see how they should appear on either Mac or a PC.

Mac users only:

On connecting your Scarlett 18i8 to your Mac, a Scarlett icon will appear on the desktop:



Double-click on the icon to open the Finder window shown below:

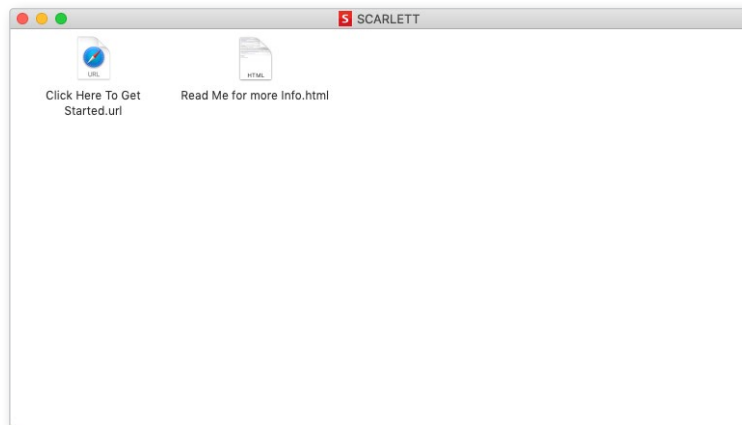

Double-click on the “Click Here to Get Started.url” icon. This will redirect you to the Focusrite website, where we recommend you register your device:



Click on “Let’s get you started”, and you’ll see a form which will be partly prefilled for you automatically. When you submit the form, you’ll see options to go straight to the downloads to get the software for your Scarlett, or to follow a step by step setup guide based on how you want to use your Scarlett.

Once you have installed the Focusrite Control software to set up and configure your interface, the Scarlett will be switched out of Easy Start mode so it no longer appears as a Mass Storage Device when connected to your computer.

Your OS should switch the computer’s default audio inputs and outputs to the Scarlett. To verify this, go to **System Preferences > Sound**, and ensure the input and output are set to **Scarlett 18i8**.

For detailed setup options on a Mac, open **Applications > Utilities > Audio MIDI Setup**.

Windows only:

On connecting your Scarlett 18i8 to your PC, a Scarlett icon will appear on the desktop:

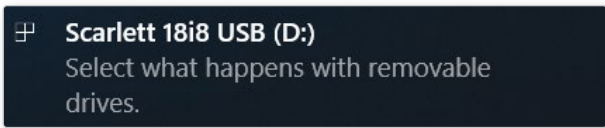

[Note that the drive letter may be something other than D:, depending on other devices connected to your PC.]

Double-click on the pop-up message to open the dialogue box shown below:

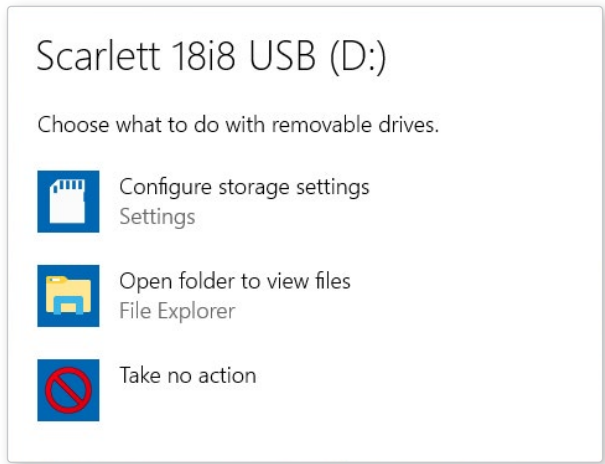

Double-click on "Open folder to view files"; this will open an Explorer window:

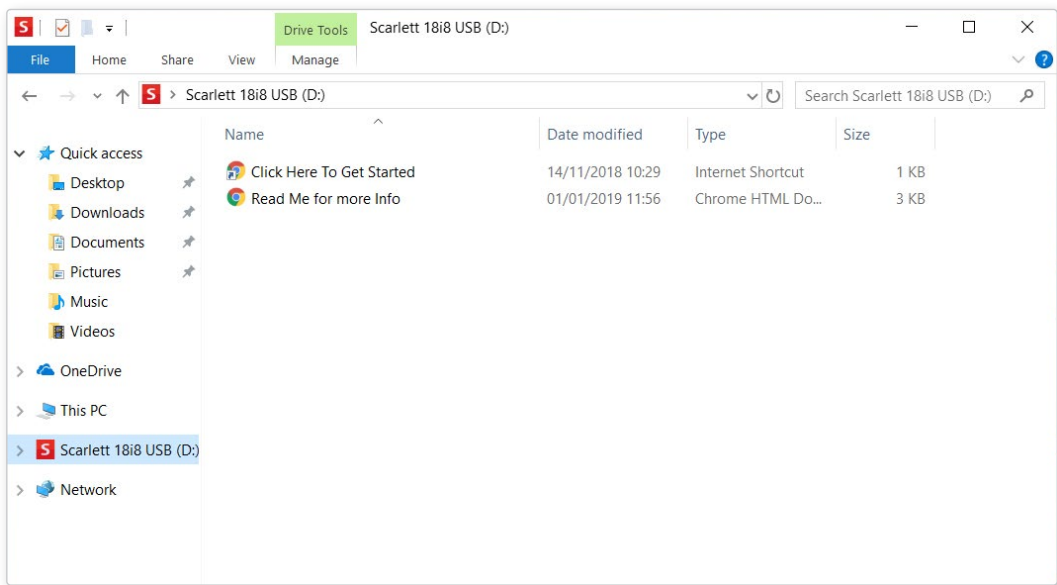

Double-click “Click Here to Get Started”. This will redirect you to the Focusrite website, where we recommend you register your device:



Click on “Let’s get you started”, and you’ll see a form which will be partly prefilled for you automatically. When you submit the form, you’ll see options to go straight to the downloads to get the software for your Scarlett, or to follow a step by step setup guide based on how you want to use your Scarlett.

Once you have installed the Focusrite Control software to set up and configure your interface, the Scarlett will be switched out of Easy Start mode so it no longer appears as a Mass Storage Device when connected to your computer.

Your OS should switch the computer’s default audio inputs and outputs to be the Scarlett. To verify this, right click on the Sound icon on the taskbar and select **Sound Settings**, and set the Scarlett as the Input and Output Device.

All users:

Note that a second file - "More Info & FAQs" - is also available during the initial set-up process. This file contains some additional information about the Focusrite Quick Start tool which you may find helpful if you have any issues with the procedure.

Once registered, you will have immediate access to the following resources:

- Focusrite Control (Mac and Windows versions available) - see NOTE below
- Multi-language User Guides

You can find the licence codes and links for the optional bundled software in your Focusrite account. To find out what bundled software is included with Scarlett 3rd generation, please visit our website:

focusrite.com/scarlett

NOTE: Installing Focusrite Control will also install the correct driver for your device. Focusrite Control is available to download at any time, even without registering: see "Manual Registration" below.

Manual Registration

If you decide to register your Scarlet at a later date you can do so at:

customer.focusrite.com/register

You will need to enter the Serial Number manually: this number can be found on the base of the interface itself, and also on the barcode label on the side of the box.

We recommend you download and install our Focusrite Control application, as this will disable Easy Start mode and unlock the full potential of the interface. Initially, when in Easy Start mode, the interface will function at sample rates up to 48 kHz and the MIDI I/O is disabled. Once Focusrite Control is installed on your computer, you can work at sample rates up to 192 kHz.

If you decide not to download and install Focusrite Control immediately, it can be downloaded at any time from:

customer.focusrite.com/support/downloads

To force your Scarlett out of Easy Start mode without first registering it, connect it to your computer and press and hold the **48V** button for five seconds. This will ensure your Scarlett has full functionality. Please bear in mind that should you wish to register your Scarlett after taking this action, you will need to do so manually, as explained above.

HARDWARE FEATURES

Front Panel

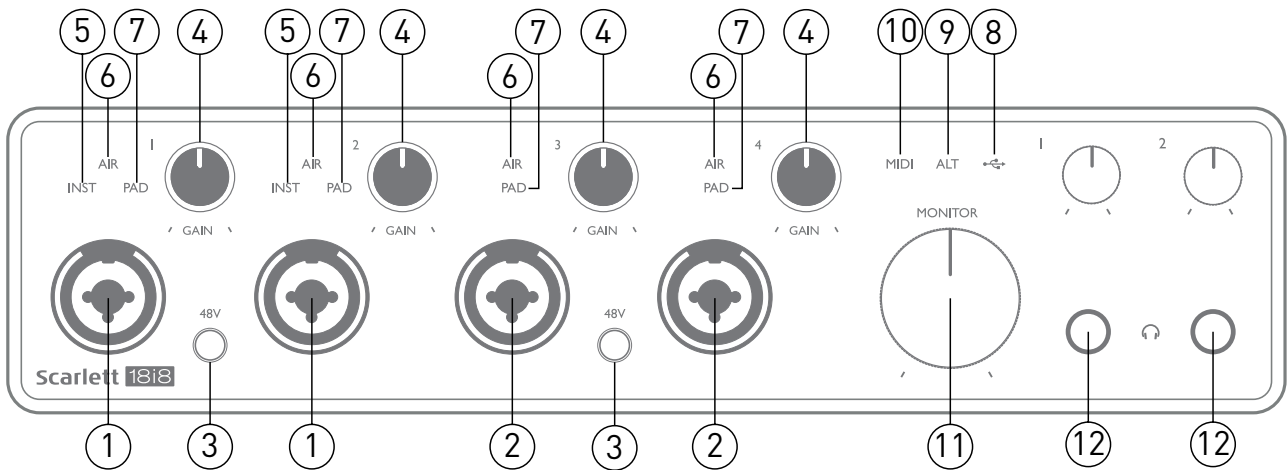

1. Inputs **1** and **2** – “Combo” input sockets - connect microphones, instruments (e.g., guitar), or line level signals here. Combo sockets accept both XLR and ¼” (6.35 mm) jacks. Microphones connect using XLR plugs: instruments and line level signals connect via ¼” (6.35 mm) jack plugs of either TS or TRS type. The preamp gain is appropriate for microphones when an XLR plug is inserted, and for higher level signals when a jack plug is inserted. Do not connect anything other than a microphone - e.g., the output of a sound module or FX unit - via an XLR plug, as the signal level will overload the preamp, resulting in distortion; , if phantom power is enabled, you may damage your equipment.
2. Inputs **3** and **4** – XLR Combo type input sockets – as [1], but accept mic or line level signals only. Direct connection of instruments should be via Inputs 1 and/or 2.
3. **48V** – two switches enabling 48 V phantom power at the XLR contacts (mic inputs) of the Combo connectors, in pairs (1 & 2; 3 & 4). The 48V indicators illuminate red when phantom power is selected.
4. **GAIN 1** to **GAIN 4** - adjust the input gain for the signals at Inputs 1 to 4 respectively. The gain controls have tri-colour LED ‘rings’ to confirm signal level: green indicates an input level of at least -24 dBFS (i.e., ‘signal present’), the ring turns amber at -6 dBFS to indicate the signal is close to clipping, and red at 0 dBFS (digital clipping).
5. **INST** – the input type for the jack at Inputs 1 and 2 can be selected in Focusrite Control. The red LEDs illuminate when INST is selected. With INST selected, the gain range and input impedance are altered (relative to LINE), and the input is made unbalanced. This optimises it for the direct connection of instruments (via a 2-pole (TS) jack plug). When INST is off, the inputs are suitable for the connection of line level signals. Line level signals may be connected either in balanced form via a 3-pole (TRS) jack or unbalanced, via a 2-pole (TS) jack..
6. **AIR** – four yellow LEDs indicating selection of AIR mode for Inputs 1 to 4. AIR mode, selected from Focusrite Control, modifies the frequency response of the input stage to model the classic, transformer-based Focusrite ISA microphone preamps.
7. **PAD** – four green LEDs; illuminate when PAD is selected from Focusrite Control for Inputs 1 to 4. PAD decreases the signal level going to your DAW by 10 dB; use when the input source has a high level.
8.  **USB LED** - a green LED illuminates when the Scarlett is connected and recognised by your computer.

9. **ALT** – when **Speaker Switching** is activated via Focusrite Control, the main monitor mix is diverted from **LINE OUTPUTS 1** and **2** to **LINE OUTPUTS 3** and **4**. Connect a pair of secondary monitor speakers to the **LINE OUTPUTS 3** and **4**, and select **ALT** to switch between your main monitors and the secondary pair. 'ALT' illuminates green when selected. This function may also be selected from Focusrite Control.
10. **MIDI LED** – a green LED illuminates when MIDI data is received at the **MIDI IN** port.
11. **MONITOR** – main monitor output level control – normally adjusts the level at Outputs 1 and 2 on the rear panel, but will follow selection of ALT mode [9], and will also control the level of any other outputs assigned to Hardware Control in Focusrite Control.
12.  - Connect one or two pairs of stereo headphones at the two ¼" (6.25 mm) TRS jack sockets below the headphone volume controls 1 and 2. The headphone outputs have independent mixes and carry the signals currently routed to Headphone outputs 1 and 2 (outputs 5 & 6 and 7 & 8 as stereo pairs) respectively in Focusrite Control.

Rear Panel

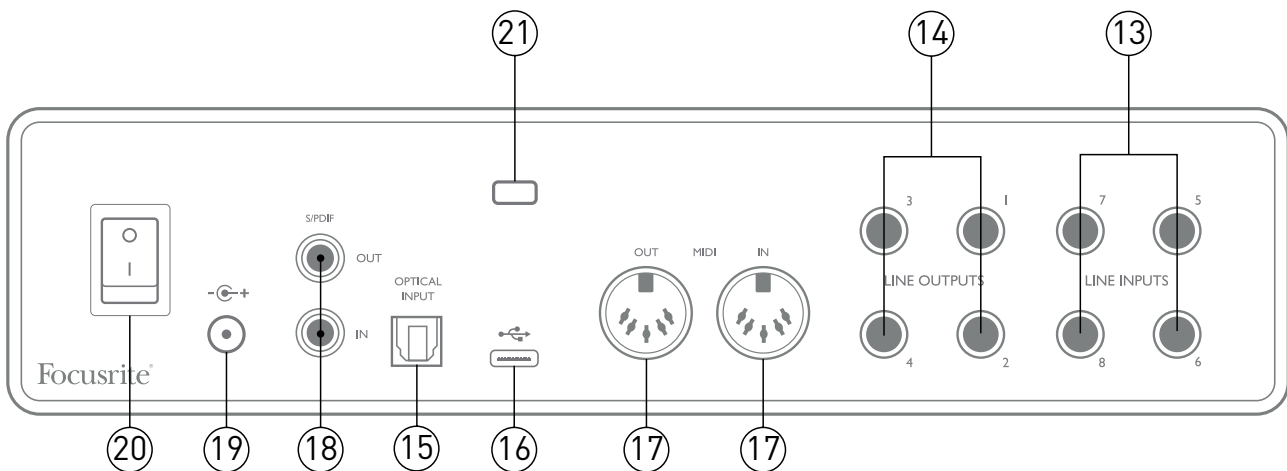

13. **LINE INPUTS 5 to 8** – the inputs are balanced, on ¼" (6.35 mm) jack sockets. Connect further line level sources here, using either ¼" TRS (balanced) or TS (unbalanced) jack plugs.
14. **LINE OUTPUTS 1 to 4** – four balanced analogue line outputs on ¼" (6.35 mm) jack sockets; use TRS jacks for a balanced connection or TS jacks for unbalanced. Outputs 1 and 2 will normally be used to drive the primary monitoring system, though the signals available at any of these outputs may be defined in Focusrite Control. Outputs 3 and 4 can be used for driving alternative speakers (i.e., midfield, nearfield, etc.), or to drive outboard FX processors.
15. **OPTICAL INPUT** – TOSLINK connector able to carry eight channels of digital audio in ADAT format at 44.1/48 kHz sample rate or four channels at 88.2/96 kHz. These are additional inputs (13 to 20) to the Scarlett 18i8. The optical input can also be used as an S/PDIF input if you need to connect equipment with an optical S/PDIF output. Note that the optical input is disabled when sample rates of 176.4/192 kHz are in use.
16.  USB 2.0 port – Type C connector; connect the Scarlett 18i8 to your computer with the cable supplied.
17. **MIDI IN** and **MIDI OUT** – standard 5-pin DIN sockets for connection of external MIDI equipment. The Scarlett 18i8 acts as a MIDI interface, allowing MIDI data to/from your computer to be distributed to additional MIDI devices.
18. **SPDIF IN** and **OUT** – two phono (RCA) sockets carrying two-channel digital audio signals in and out of the Scarlett 18i8 in S/PDIF format. Like all the other inputs and outputs, signals at these connectors may be routed in Focusrite Control.
19. External DC power input – power the Scarlett 18i8 via the separate AC adaptor (PSU) supplied with the unit. Note that the Scarlett 18i8 cannot be powered via its USB port from the host computer.
20. Power On/Off switch.
21. **K** (Kensington security slot) – secure your Scarlett 18i8 to a suitable structure if desired.

Connecting your Scarlett 18i8

Power

Your Scarlett 18i8 should be powered from an external 12 V DC, 1.2 A mains adaptor. A suitable adaptor is supplied with the unit.

IMPORTANT: We strongly recommend you only use the supplied mains adaptor. Failure to use this adaptor is likely to permanently damage the unit and will also invalidate your warranty.

USB

USB Port Types: The Scarlett 18i8 has a single Type C USB 2.0 port (on the rear panel). Once the software installation is complete, connect the Scarlett 18i8 to your computer; if your computer has a Type A USB port we recommend you use the Type A-to-Type C USB cable provided with the unit. If your computer has a Type C USB port, please obtain a Type C-to-Type C cable from a computer supplier.

USB Standards: Note that because the Scarlett 18i8 is a USB 2.0 device, the USB connection requires a USB 2.0 compliant port on your computer. It will not operate with USB 1.0/1.1 ports: however, a USB 3.0 port will support a USB 2.0 device.

When the USB cable has been connected, turn the Scarlett 18i8 on with the rear panel power switch.

Audio Setup in your DAW

The Scarlett 18i8 is compatible with any Windows-based DAW that supports ASIO or WDM or any Mac-based DAW that uses Core Audio. After following the Getting Started procedure described on page 5, you can start using your Scarlett 18i8 with the DAW of your choice.

To allow you to get started if you do not already have a DAW application installed on your computer, both Pro Tools | First and Ableton Live Lite are included; these will be available to you once you've registered your Scarlett 18i8. If you need help installing either DAW, please visit our Getting Started pages at focusrite.com/get-started, where Getting Started videos are available.

Operating instructions for Ableton Live Lite and Pro Tools | First are beyond the scope of this User Guide, but both applications include a full set of Help files. Instructions are also available at avid.com and ableton.com respectively.

Please note - your DAW may not automatically select the Scarlett 18i8 as its default I/O device. You must manually select **Focusrite USB ASIO** as the driver on your DAW's **Audio Setup*** page. Please refer to your DAW's documentation (or Help files) if you are unsure where to select the ASIO/ Core Audio driver. The example below shows the correct configuration in the Ableton Live Lite **Preferences** panel (Windows version shown).

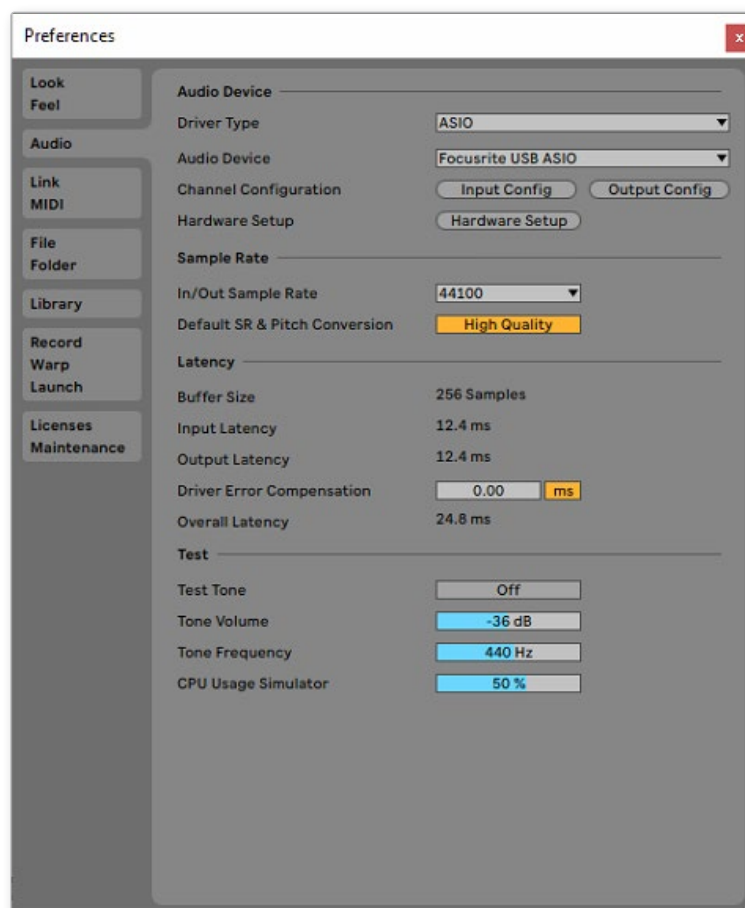

* Typical name. Terminology may differ between DAWs.

Once the Scarlett 18i8 is set as the preferred Audio Device* in your DAW, all 18 inputs and eight outputs will appear in your DAW's Audio I/O preferences (note however Ableton Live Lite is limited to a maximum of four simultaneous mono input channels and four simultaneous mono output channels). Depending on your DAW, you may need to enable certain inputs or outputs before use.

The two examples below show two inputs and two outputs enabled in Ableton Live Lite's **Input Config** and **Output Config** pages.

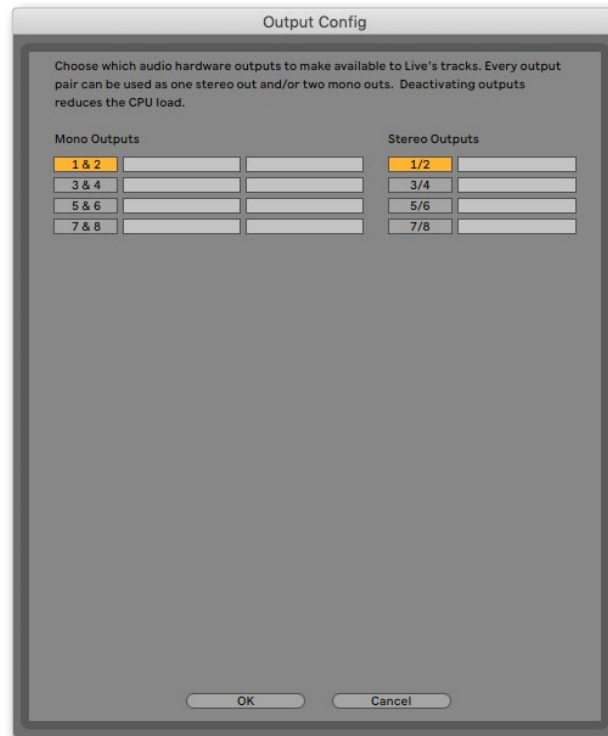

* Typical name. Terminology may differ between DAWs.

Loopback Inputs

You will notice two additional inputs - "Inputs 11 & 12" - will be listed on the Input Config page of your DAW's I/O Preferences. These are virtual "loopback" inputs within software, not additional physical inputs. They can be used to record DAW tracks from sources within your computer, e.g., from a web browser. Focusrite Control includes a **Loopback 1-2** mix tab, where you can choose which inputs to record.

Full details of how to use the loopback inputs can be found in the Focusrite Control User Guide.

Examples of Usage

The Scarlett 18i8 is an excellent choice for several different recording and monitoring applications. Some typical configurations are shown below.

Connecting microphones and instruments

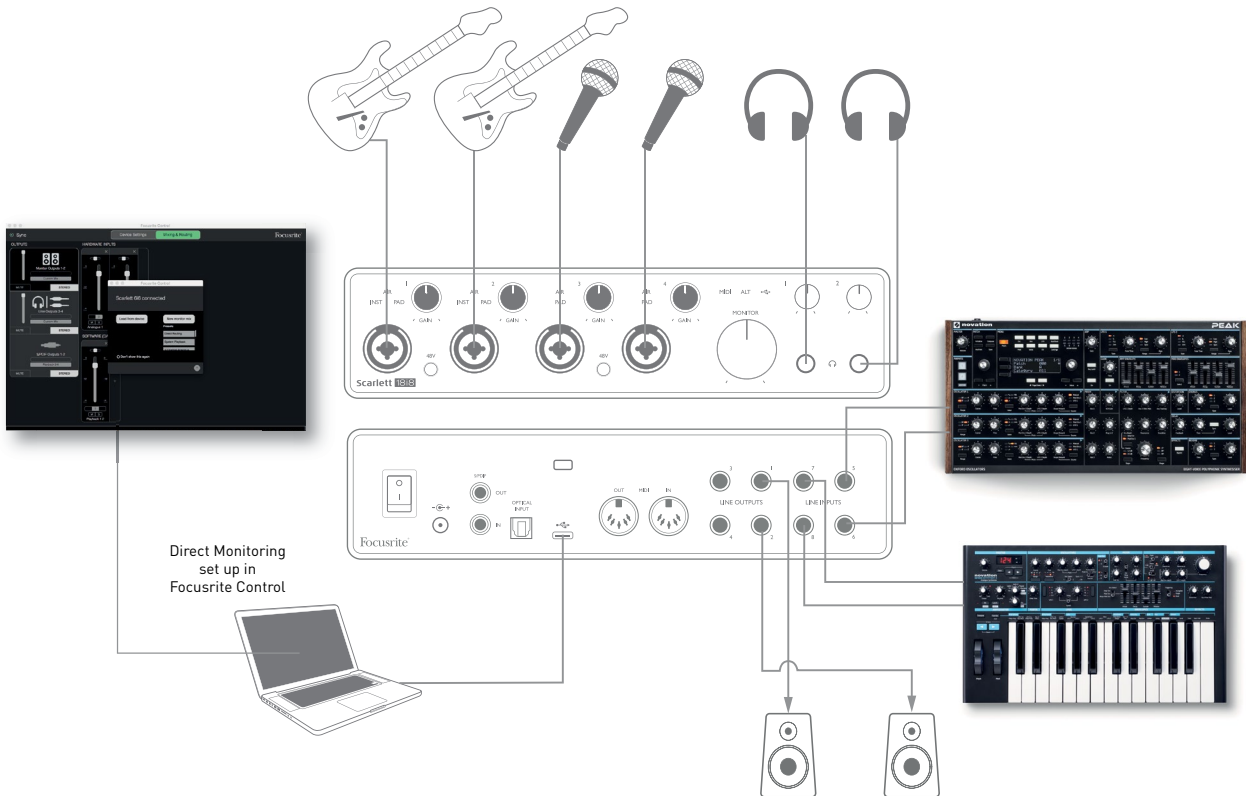

This setup shows a configuration for recording a group of musicians with DAW software on a computer. Inputs 1 and 2 are used for two guitars, while Inputs 3 and 4 are used for vocals. Two stereo keyboards are connected to Inputs 5 to 8 at the rear. During recording, playback of the DAW can be monitored on the loudspeakers (if they are in a separate room – otherwise use headphones), and Focusrite Control can be configured to provide each vocalist with their own dedicated headphone mix. This can consist of any mix of themselves, the other singer, the guitars and keyboards, plus any other DAW tracks that may have already been recorded.

The front panel input sockets are XLR Combo type, which accept either a male XLR connector (you will have one on the end of your microphone cable) or a ¼" (6.35 mm) jack plug. Note the Scarlett 18i8 has no "Mic/line" switch – the preamplifier stage is automatically configured for a microphone when you plug an XLR into the input, and for a line or instrument when you connect a jack plug. Select **INST** in Focusrite Control (on the **Device Settings** page) if you are connecting a musical instrument (like a guitar) via an ordinary 2-pole guitar jack. **INST** should be off if you are connecting a line level source such as the balanced output of an external audio mixer via a 3-pole (TRS) jack. Note the Combo connector accepts both types of jack plug.

If you are using condenser microphones, press the **48V** button to supply phantom power to the mics. (In the example, this would be the **48V** button for Inputs 3 and 4.) Most modern microphones of other types, e.g., dynamic or ribbon, will not be damaged by the inadvertent application of phantom power, but note that some older mics may be; if you have any doubt, please check the specification of your mic to ensure it is safe to use.

Input channels 1 to 4 of the Scarlett 18i8 each have a PAD function: when selected from Focusrite Control (**PAD** illuminates green when active), the signal level fed to your DAW is reduced by 10 dB. You will find this useful if the output level of your source is particularly “hot”, when you might notice clipping or the gain halo turning red, even at minimum gain.

Low Latency Monitoring

You will frequently hear the term “latency” used in connection with digital audio systems. In the case of the simple DAW recording application described above, latency will be the time it takes for your input signals to pass through your computer and audio software, and back out again via your audio interface. While not an issue for most simple recording situations, under some circumstances, latency can be a problem for a performer who wishes to record while monitoring their input signals. This might be the case if you need to increase the size of your DAW’s recording buffer, which could be necessary when you record overdubs on a particularly large project using many DAW tracks, software instruments and FX plug-ins. Common symptoms of a buffer setting too low include audio glitching (clicks and pops) or an unusually high CPU overhead within your DAW (most DAWs have a CPU load monitoring feature). Most DAWs will allow you to adjust buffer size from their Audio Preferences* control page.

The Scarlett 18i8, in conjunction with Focusrite Control, allows zero latency monitoring, which overcomes this problem. You can route your input signals directly to the Scarlett 18i8’s headphone outputs. This enables the musicians to hear themselves with zero latency – i.e., in “real time” – along with the computer playback. The input signals to the computer are not affected in any way by this setting. However, note that any effects being added to the live instruments by software plug-ins will not be heard in the headphones although the FX will still be present on the recording.

When using Direct Monitoring, ensure your DAW software is not set to route any inputs (what you are currently recording) to any outputs. If it is, the musicians will hear themselves “twice”, with one signal audibly delayed as an echo.

* Typical name. Terminology may differ between DAWs

Connecting Scarlett 18i8 to loudspeakers

The 1/4" **LINE OUTPUTS 1** and **2** jacks on the rear panel will normally be used to send audio to monitoring speakers. Active monitors have internal amplifiers with a volume control, and may be connected directly. Passive loudspeakers will require a separate stereo amplifier; the rear panel outputs should be connected to the amplifier's inputs.

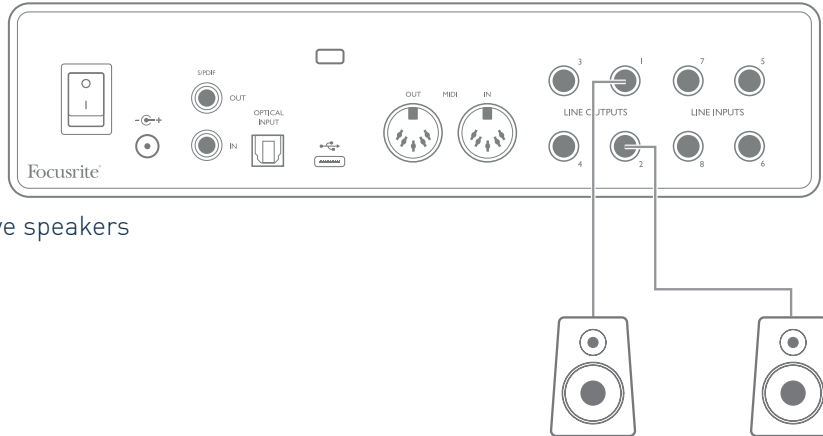

Connecting to active speakers

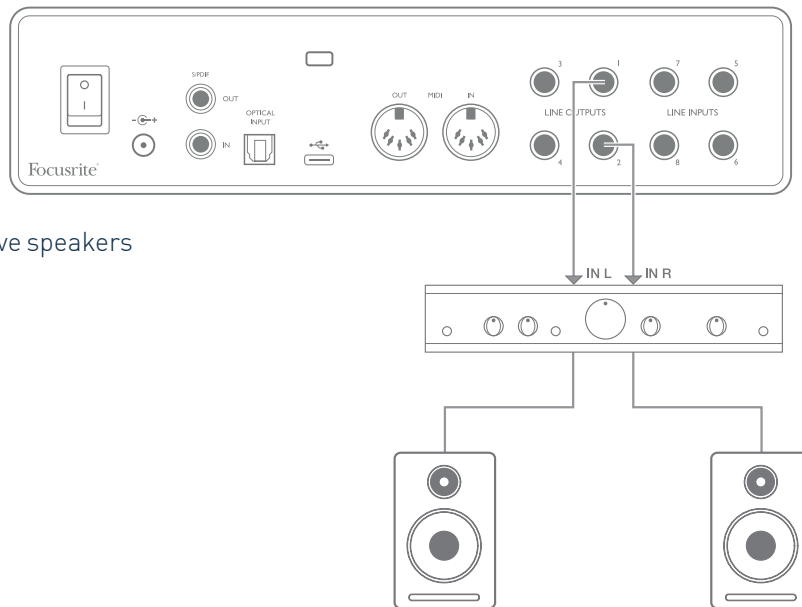

Connecting to Passive speakers

All the line output connectors are 3-pole (TRS) 1/4" (6.35 mm) jack sockets, and are electronically balanced. Typical consumer (hi-fi) amplifiers and small powered monitors will probably have unbalanced inputs, either on phono (RCA) sockets, or via a 3.5 mm 3-pole jack plug intended for direct connection to a computer. In either case, use a cable with jack plugs at one end.

Professional active monitors and professional power amplifiers will generally have balanced inputs.

LINE OUTPUTS 1 to **4** incorporate “anti-thump” circuitry to protect your speakers if the Scarlett 18i8 is turned on while the speakers (and amplifier if used) are connected and active.

NOTE: You run the risk of creating an audio feedback loop if loudspeakers are active at the same time as a microphone! We recommend you always mute (or turn off) monitoring loudspeakers while

recording, and use headphones when overdubbing.

Speaker Switching (Main/ALT)

The 18i8's ALT function makes adding a second pair of monitors easy: connect the second pair to **LINE OUTPUTS 3 and 4**. After enabling **Speaker Switching** in Focusrite Control, you can switch between your main monitors and the secondary pair by clicking on the on-screen **MAIN** and **ALT** buttons. When ALT is active, the main mix output will be fed to the **LINE OUTPUTS 3 and 4** instead of **1 and 2**, and the green **ALT** LED will light to confirm this.

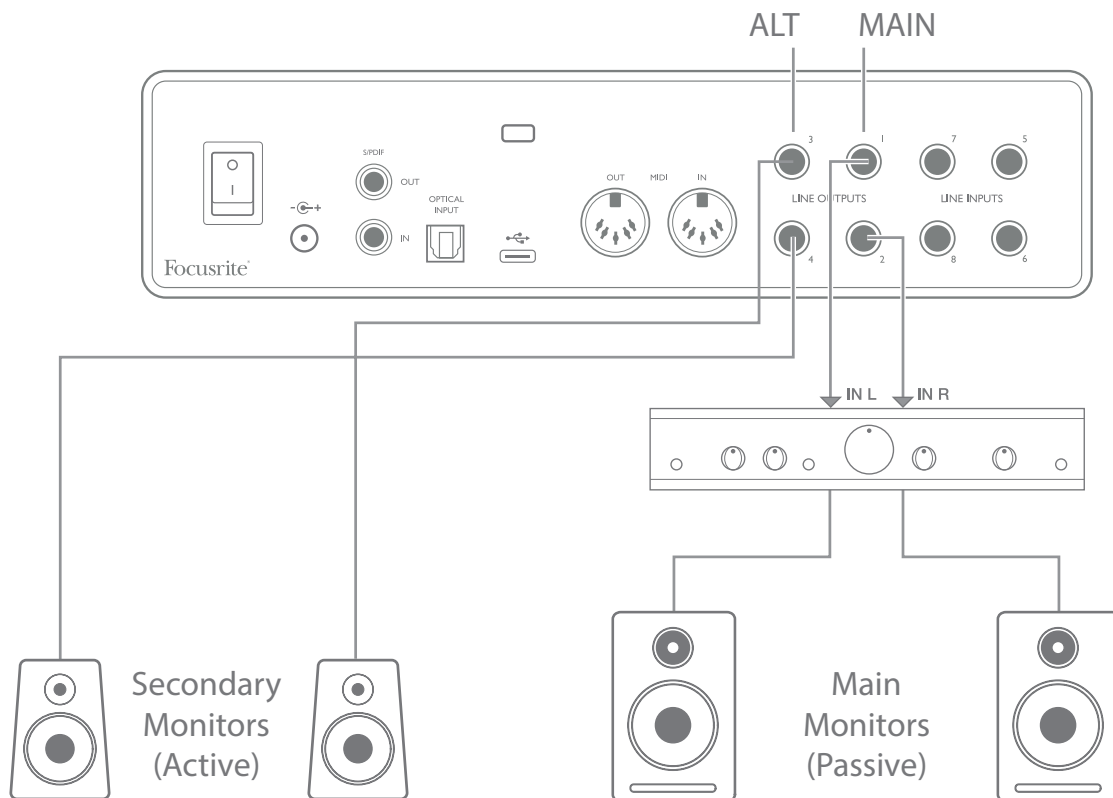

Note that as you switch between **MAIN** and **ALT**, the Line Outputs feeding the pair of speakers not in use are muted. When **Speaker Switching** is disabled, Line Outputs 1 to 4 are all initially muted (for safety); you will need to unmute the appropriate outputs in Focusrite Control. Please see the Focusrite Control manual for more details of Speaker Switching.

Using the ADAT connection

In addition to the eight analogue inputs, the Scarlett 18i8 has an optical ADAT input port which can provide an additional eight audio inputs at 44.1/48 kHz sample rate or four at 88.2/96 kHz. (Note that the optical ADAT input port does not support 176.4/192 kHz sample rates.) Using a separate 8-channel microphone preamplifier equipped with an ADAT output – such as the Focusrite Scarlett OctoPre – provides a simple and excellent method of expanding the Scarlett 18i8's input capability.

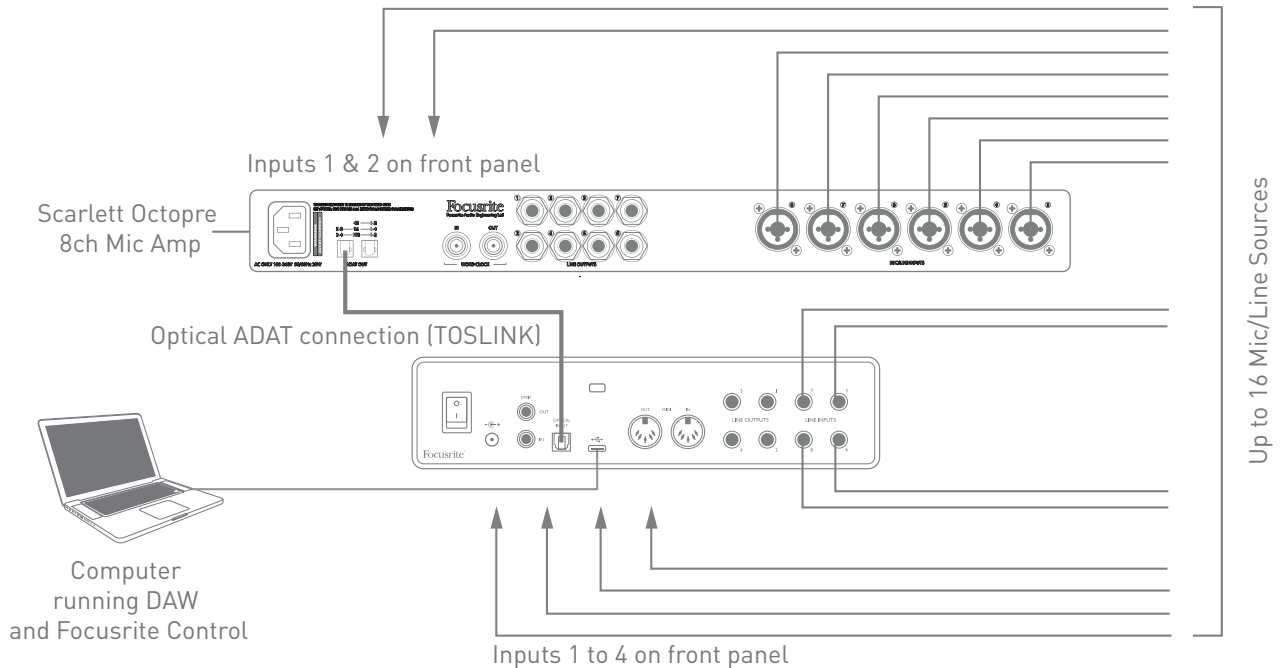

The Scarlett OctoPre's ADAT output is connected to the Scarlett 18i8's ADAT input with a single TOSLINK optical cable. To synchronise the devices, set the clock source of the Scarlett OctoPre to **Internal** and Scarlett 18i8 (via Focusrite Control) to **ADAT**.

TIP: When interconnecting two digital devices by any method, always ensure both are set to the same sample rate.

The additional inputs realised by use of the ADAT port may be routed using Focusrite Control in the same way as the other inputs. The additional inputs can form part of any musician's headphone mix, as required.

Using the Scarlett 18i8 as a stand-alone mixer

The Scarlett 18i8 has the ability to store a mix configuration defined in Focusrite Control within the hardware. This feature lets you configure it – for example, as an on-stage keyboard mixer – using your computer, and upload the configuration to the device itself. Then you can use the Scarlett 18i8 as a simple local mixer as part of your keyboard rig to control the overall mix of multiple keyboards.

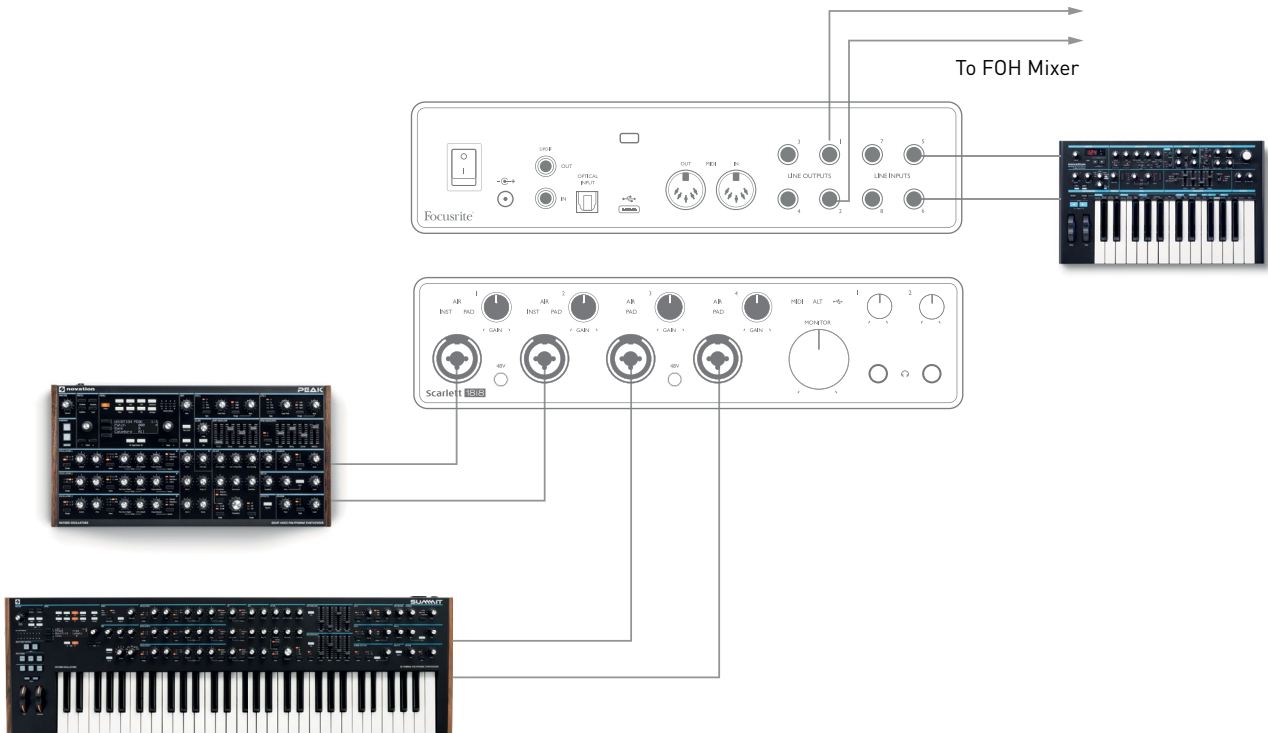

In the example illustrated, three stereo keyboards are connected to the inputs of the Scarlett 18i8; the Monitor Outputs go to the main PA system. The performer can adjust the gain for two of the keyboards against the third from the front panel; he/she can also adjust the overall level of the keyboard mix.

Using the Scarlett 18i8 as a stand-alone preamp

Using the digital connections on the Scarlett 18i8 3rd gen, S/PDIF, it is possible to use it as a two-channel standalone preamp.

You can connect two input sources to any of the inputs on the Scarlett (microphone, line or inst) and using Focusrite Control you can route the analogue inputs directly to the S/PDIF outputs. Then you can connect the S/PDIF output to the S/PDIF input on another interface to expand that interface's channel count, for example a second Scarlett 18i8, or larger interface such as a Scarlett 18i20.

FOCUSRITE CONTROL

Focusrite Control software allows flexible mixing and routing of all audio signals to the physical audio outputs, as well as control of output monitor levels. Sample rate selection and digital sync options are also available from Focusrite Control.

NOTE: Focusrite Control is a generic product, and may be used with other Focusrite interfaces. When you connect an interface to your computer and launch Focusrite Control, the model of interface is automatically detected, and the software configured to suit the inputs and outputs, and other facilities, available on the hardware.

IMPORTANT: A separate Focusrite Control User Guide can be downloaded once you have completed the on-line registration process. This describes the use of Focusrite Control in full detail, together with examples of application.

To open Focusrite Control:



Installing Focusrite Control on your computer will place the Focusrite Control icon on the dock or desktop. Click the icon to launch Focusrite Control.

Assuming your Scarlett interface is connected to your computer with the USB cable, the Focusrite Control GUI (Graphical User Interface) will appear as shown below (Mac version illustrated).

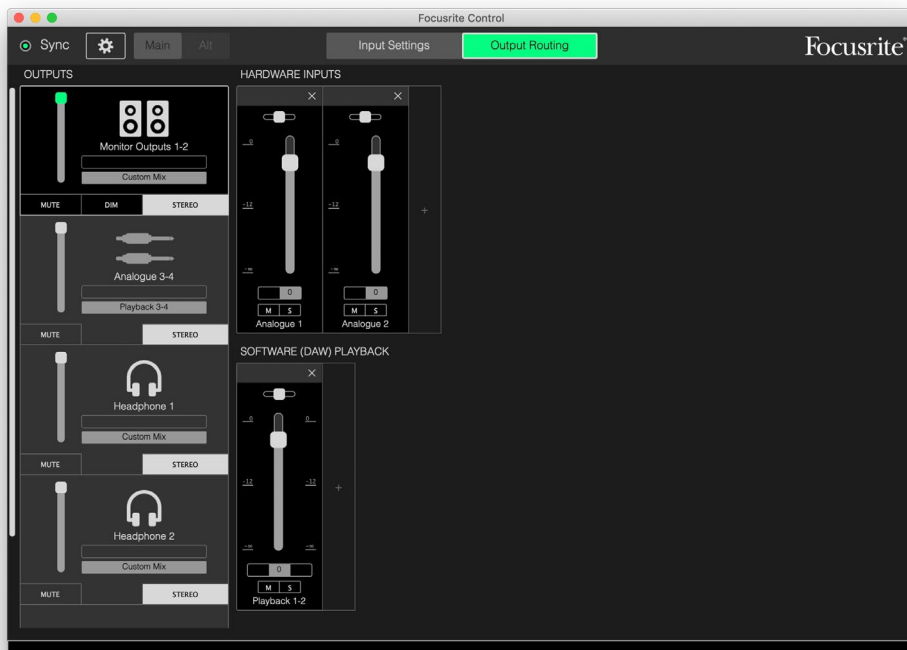

Please refer to the Focusrite Control User Guide for further details. This is available from:

focusrite.com/downloads

Channel Listing tables

The following table provides the channel routings when preset option “Direct Routing” is selected in Focusrite Control; see the screen image on page 22.

At 44.1 kHz and 48 kHz sample rates:

CH NO.	INPUTS	OUTPUTS
1	Input 1	Output 1 + S/PDIF 1
2	Input 2	Output 2 + S/PDIF 2
3	Input 3	Output 3
4	Input 4	Output 4
5	Input 5	Headphones 1 L
6	Input 6	Headphones 1 R
7	Input 7	Headphones 2 L
8	Input 8	Headphones 2 R
9	S/PDIF 1	
10	S/PDIF 2	
11	Loopback 1	
12	Loopback 2	
13	ADAT 1	
14	ADAT 2	
15	ADAT 3	
16	ADAT 4	
17	ADAT 5	
18	ADAT 6	
19	ADAT 7	
20	ADAT 8	

At 88.2 kHz and 96 kHz sample rates:

CH NO.	INPUTS	OUTPUTS
1	Input 1	Output 1 + S/PDIF 1
2	Input 2	Output 2 + S/PDIF 2
3	Input 3	Output 3
4	Input 4	Output 4
5	Input 5	Headphones 1 L
6	Input 6	Headphones 1 R
7	Input 7	Headphones 2 L
8	Input 8	Headphones 2 R
9	S/PDIF 1	
10	S/PDIF 2	
11	Loopback 1	
12	Loopback 2	
13	ADAT 1	
14	ADAT 2	
15	ADAT 3	
16	ADAT 4	

At 176.4 kHz and 192 kHz sample rates:

CH NO.	INPUTS	OUTPUTS
1	Input 1	Output 1 + S/PDIF 1
2	Input 2	Output 2 + S/PDIF 2
3	Input 3	Output 3
4	Input 4	Output 4
5	Input 5	Headphones 1 L
6	Input 6	Headphones 1 R
7	Input 7	Headphones 2 L
8	Input 8	Headphones 2 R
9	S/PDIF 1	
10	S/PDIF 2	

SPECIFICATIONS

Performance Specifications

All performance figures measured in accordance with the provisions of AES17, as applicable.

Configuration	
Inputs	18: analogue (8), ADAT (8), S/PDIF (2)
Outputs	10: analogue (4), headphones (2 x 2), S/PDIF (2)
Mixer	Fully assignable 20-in/8-out software mixer (Focusrite Control)
Custom Mixes	10 mono
Maximum custom mix inputs	20 mono
Digital Performance	
Supported sample rates	44.1 kHz, 48 kHz, 88.2 kHz, 96 kHz, 176.4 kHz and 192 kHz
Microphone Inputs	
Frequency Response	20 Hz - 20kHz \pm 0.1dB
Dynamic Range	111 dB (A-weighted)
THD+N	< 0.0012% (minimum gain, -1 dBFS input with 22 Hz/22 kHz bandpass filter)
Noise EIN	-128 dB (A-weighted)
Maximum input level	+9 dBu at minimum gain
Gain Range	56 dB
Line Inputs 1 to 4	
Frequency Response	20 Hz to 20 kHz \pm 0.1 dB
Dynamic Range	110.5 dB (A-weighted)
THD+N	< 0.002% (minimum gain, -1 dBFS input with 22 Hz/22 kHz bandpass filter)
Maximum input level	+22 dBu at minimum gain
Gain Range	56 dB

Instrument Inputs	
Frequency Response	20 Hz to 20 kHz \pm 0.1 dB
Dynamic Range	110 dB (A-weighted)
THD+N	< 0.03% (minimum gain, -1 dBFS input with 22 Hz/22 kHz bandpass filter)
Maximum input level	+12.5 dBu at minimum gain
Gain Range	56 dB
Line Inputs 5 to 8	
Frequency Response	20 Hz to 20 kHz \pm 0.1 dB
Dynamic Range	110.5 dB (A-weighted)
THD+N	< 0.002% (minimum gain, -1 dBFS input with 22 Hz/22 kHz bandpass filter)
Maximum input level	18 dBu at minimum gain
Line Outputs 1 to 4	
Frequency Response	20 Hz to 20 kHz \pm 0.1 dB
Dynamic Range	108.5 dB (A-weighted)
THD+N	< 0.002% (-1 dBFS input with 22 Hz/22 kHz bandpass filter)
Maximum Output Level (0 dBFS)	+15.5 dBu (balanced)
Headphone Outputs	
Frequency Response	20 Hz to 20 kHz \pm 0.1 dB
Dynamic Range	104 dB (A-weighted)
THD+N	< 0.002% (measured at +6 dBu with 22 Hz/22 kHz bandpass filter)
Maximum Output Level	+7 dBu

Physical and Electrical Characteristics

Analogue Inputs 1 & 2	
Connectors	XLR Combo type: Mic/Line/Inst, on front panel
Mic/Line switching	Automatic
Line/Instrument switching	Via software from Focusrite Control
Phantom power	Shared 48 V phantom power switch for inputs 1 and 2
Analogue Inputs 3 & 4	
Connectors	XLR Combo type: Mic/Line, on front panel
Mic/Line switching	Automatic
Phantom power	Shared 48 V phantom power switch for inputs 3 and 4
Analogue Inputs 5 to 8	
Connectors	4 x balanced ¼" TRS jacks on rear panel
Analogue Outputs 1 to 8	
Connectors (Outputs 1 to 4)	4 x balanced ¼" TRS jacks on rear panel
Stereo headphone outputs (Outputs 5 to 8)	2 x ¼" TRS jacks on front panel
Main monitor output level control	On front panel
Headphones level controls	
Other I/O	
Optical input	TOSLINK optical connector carrying 8 channels @ 44.1/48 kHz or 4 channels @ 88.2/96 kHz in ADAT format
S/PDIF I/O	2 x phono (RCA) or via Optical input (selected via Focusrite Control)
USB	1 x USB 2.0 Type C connector
MIDI I/O	2 x 5-pin DIN sockets

Front Panel indicators	
USB power	Green LED
Gain Halos	Tri-colour LED rings (with GAIN controls)
Phantom power	2 x red LEDs
Instrument mode	2 x red LEDs
AIR mode	4 x yellow LEDs
Pad active	4 x green LEDs
MIDI data received	Green LED
ALT speaker mode	Green LED
Weight and Dimensions	
W x H x D	241 mm x 61 mm x 159.5 mm 9.49 in x 2.40 in x 6.28 in
Weight	1.335 kg 2.94 lb

TROUBLESHOOTING

For all troubleshooting queries, please visit the Focusrite Help Centre at support.focusrite.com.

COPYRIGHT AND LEGAL NOTICES

Full Terms and Conditions of the Warranty can be found at focusrite.com/warranty.

Focusrite is a registered trade mark and Scarlett 18i8 is a trade mark of Focusrite Audio Engineering Limited.

All other trade marks and trade names are the property of their respective owners.
2021 © Focusrite Audio Engineering Limited. All rights reserved.